

Instalacijski kanali
RIS

2013

elba

Pregled instalacijskih kanalov RIS:

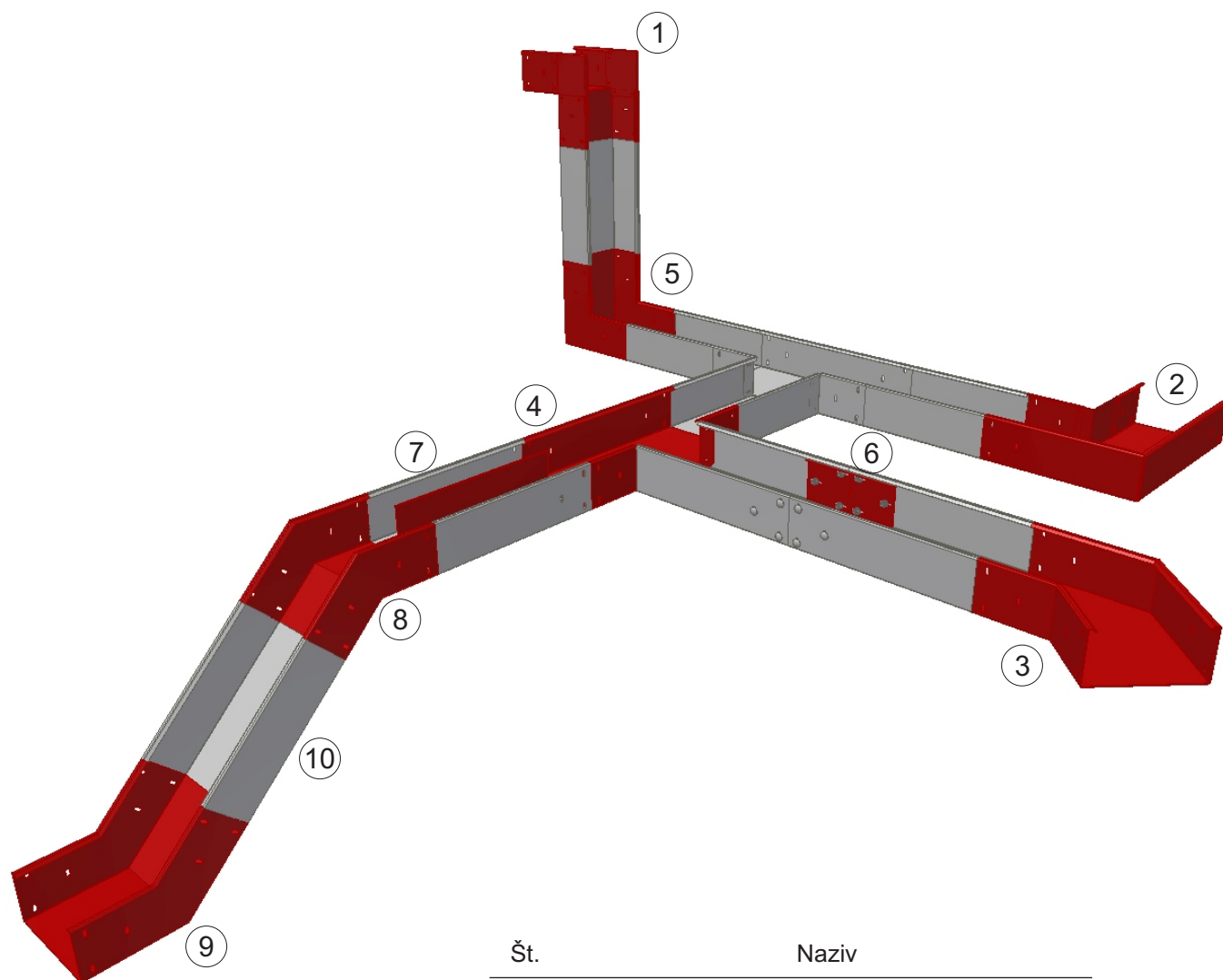

Št.	Naziv
1	Zunanje koleno 90 RIS
2	Ravninsko koleno 90 RIS
3	Ravninsko koleno 45 RIS
4	T koleno RIS
5	Notranje koleno 90 RIS
6	Spojnica RIS
7	Pregrada RIS
8	Zunanje koleno 45 RIS
9	Notranje koleno 45 RIS
10	Instalacijski kanal RIS

2 mm

Instalacijski kanal RIS

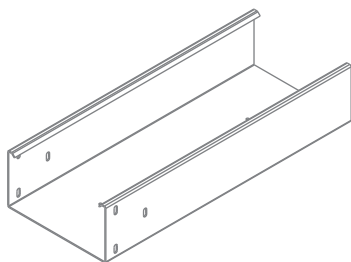

Material:		Pocinkana pločevina					
Koda	↕ mm	↔ mm	↔ m	Deb. pl. mm	Teža kg/kos	Enota	
127	40	40	2	2	4,2	m	
140	50	50	2	2	5,2	m	
141	60	80	2	2	6,9	m	
111	100	100	2	2	10,4	m	
112	100	200	2	2	13,4	m	
205	100	300	2	2	16,7	m	

2 mm

Instalacijski kanal RIS + pregrada

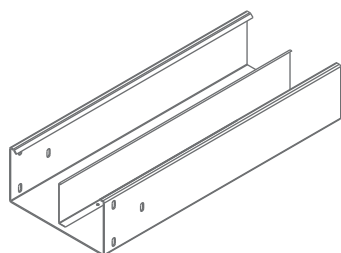

Material:		Pocinkana pločevina					
Koda	↕ mm	↔ mm	↔ m	Deb. pl. mm	Teža kg/kos	Enota	
291	100	200	2	2	15,3	m	

2 mm

Pokrov RIS

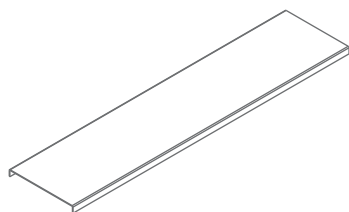

Material:		Pocinkana pločevina					
Koda	↕ mm	↔ mm	↔ m	Deb. pl. mm	Teža kg/kos	Enota	
4143	-	40	2	2	2,1	m	
4144	-	50	2	2	2,7	m	
4145	-	80	2	2	3,4	m	
4113	-	100	2	2	4	m	
4114	-	200	2	2	7,2	m	
4207	-	300	2	2	10,4	m	

2 mm

Pregrada RIS

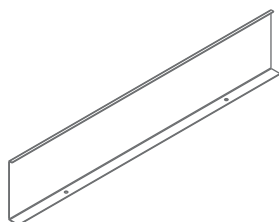

Material: Pocinkana pločevina

Koda	↑ mm	↔ mm	↔ m	Deb. pl. mm	Teža kg/kos	Enota
138	-	-	2	1	1.9	kos

OPOMBA: Samo za instalacijski kanal 200x100!

2 mm

Spojnicica RIS

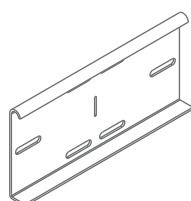

Material: Pocinkana pločevina

Koda	↑ mm	↔ mm	↔ m	Deb. pl. mm	Teža kg/kos	Enota
143	40	-	-	1	0,08	kos
153	50	-	-	1	0,10	kos
154	60	-	-	1	0,12	kos
115	100	-	-	1	0,19	kos

OPOMBA: Samo za instalacijski kanale debljine 2 mm.

2 mm

Končni element RIS

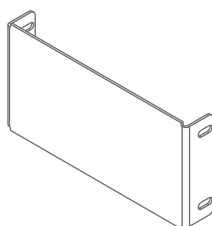

Material: Pocinkana pločevina

Koda	↑ mm	↔ mm	↔ m	Deb. pl. mm	Teža kg/kos	Enota
149	40	40	-	1	0,03	kos
150	50	50	-	1	0,04	kos
151	60	80	-	1	0,06	kos
122	100	100	-	1	0,12	kos
123	100	200	-	1	0,19	kos
175	100	300	-	1	0,45	kos

OPOMBA: Samo za instalacijski kanale debljine 2 mm.

2 mm

Ravninsko koleno 90° RIS

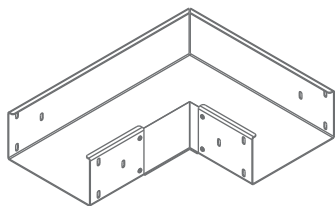

Material: Pocinkana pločevina

Koda	↕ mm	↔ mm	↔ m	Deb. pl. mm	Teža kg/kos	Enota
142	40	40	-	2	0.65	kos
146	50	50	-	2	0.90	kos
147	60	80	-	2	1.40	kos
116	100	100	-	2	2.40	kos
117	100	200	-	2	3.82	kos
208	100	300	-	2	4.81	kos

2 mm

Pokrov ravninskega kolena 90° RIS

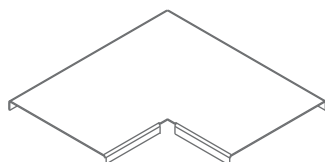

Material: Pocinkana pločevina

Koda	↕ mm	↔ mm	↔ m	Deb. pl. mm	Teža kg/kos	Enota
4142	-	40	-	2	0.23	kos
41446	-	50	-	2	0.31	kos
4147	-	80	-	2	0.52	kos
4116	-	100	-	2	0.72	kos
4117	-	200	-	2	1.65	kos
4208	-	300	-	2	2.49	kos

2 mm

Reducirno ravninsko koleno 90° RIS

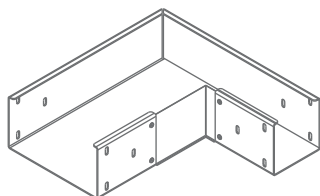

Material: Pocinkana pločevina

Koda	↕ mm	↔ mm	↔ m	Deb. pl. mm	Teža kg/kos	Enota
130L	100	200/100	-	2	2.82	kos
130D	100	200/100	-	2	2.82	kos

OPOMBA: L = levo reducirno koleno, D = desno reducirno koleno

2 mm

Pokrov reducirnega ravninskega kolena 90° RIS

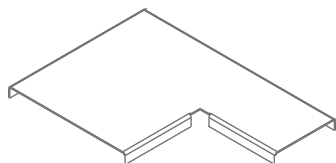

Material: Pocinkana pločevina

Koda	↑ mm	↔ mm	↔ m	Deb. pl. mm	Teža kg/kos	Enota
4130L	-	200/100L	-	2	0.91	kos
4130D	-	200/100D	-	2	0.91	kos

OPOMBA: L = pokrov levega reducirnega kolena, D = pokrov desnega reducirnega kolena

2 mm

Ravninsko koleno 45° RIS

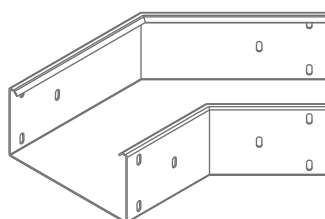

Material: Pocinkana pločevina

Koda	↑ mm	↔ mm	↔ m	Deb. pl. mm	Teža kg/kos	Enota
214	40	40	-	2	0.96	kos
215	50	50	-	2	1.2	kos
216	60	80	-	2	1.5	kos
217	100	100	-	2	2.25	kos
218	100	200	-	2	3.00	kos
271	100	300	-	2	3.75	kos

2 mm

Pokrov ravninskega kolena 45° RIS

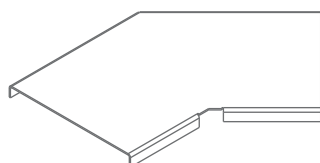

Material: Pocinkana pločevina

Koda	↑ mm	↔ mm	↔ m	Deb. pl. mm	Teža kg/kos	Enota
4214	-	40	-	2	0.23	kos
4215	-	50	-	2	0.28	kos
4216	-	80	-	2	0.44	kos
4217	-	100	-	2	0.56	kos
4218	-	200	-	2	1.00	kos
4271	-	300	-	2	1.45	kos

2 mm

T koleno RIS

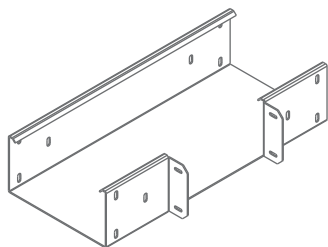

Material: Pocinkana pločevina

Koda	↕ mm	↔ mm	↔ m	Deb. pl. mm	Teža kg/kos	Enota
219	40	40/40/40	-	2	0.54	kos
180	50	50/50/50	-	2	0.69	kos
220	60	80/80/80	-	2	1.10	kos
118	100	100/100/100	-	2	1.70	kos
221	100	100/200/100	-	2	2.12	kos
134	100	200/100/200	-	2	2.24	kos
119	100	200/200/200	-	2	2.73	kos
272	100	300/300/300	-	2	4.10	kos

2 mm

Pokrov T kolena RIS

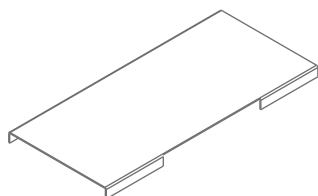

Material: Pocinkana pločevina

Koda	↕ mm	↔ mm	↔ m	Deb. pl. mm	Teža kg/kos	Enota
4219	-	40/40/40	-	2	0.18	kos
4180	-	50/50/50	-	2	0.23	kos
4220	-	80/80/80	-	2	0.37	kos
4118	-	100/100/100	-	2	0.57	kos
4221	-	100/200/100	-	2	0.51	kos
4134	-	200/100/200	-	2	1.46	kos
4119	-	200/200/200	-	2	1.38	kos
4272	-	300/300/300	-	2	1.76	kos

2 mm

Zunanje koleno 90° RIS

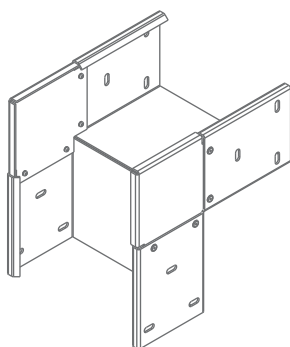

Material: Pocinkana pločevina

Koda	↕ mm	↔ mm	↔ m	Deb. pl. mm	Teža kg/kos	Enota
166	40	40	-	2	0.55	kos
223	50	50	-	2	0.80	kos
222	60	80	-	2	1.20	kos
165	100	100	-	2	1.46	kos
171	100	200	-	2	1.38	kos
273	100	300	-	2	1.76	kos

2 mm

Pokrov zunanjega kolena 90° RIS

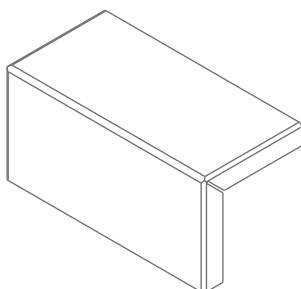

Material:		Pocinkana pločevina					
Koda	↕ mm	↔ mm	↶ m	Deb. pl. mm	Teža kg/kos	Enota	
4166	-	40	-	2	?	kos	
4223	-	50	-	2	?	kos	
4222	-	80	-	2	?	kos	
4165	-	100	-	2	?	kos	
4171	-	200	-	2	?	kos	
4273	-	300	-	2	?	kos	

2 mm

Zunanje koleno 45° RIS

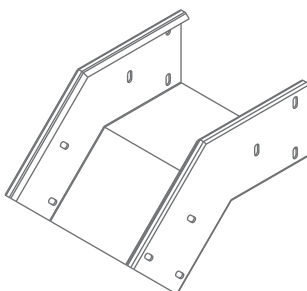

Material:		Pocinkana pločevina					
Koda	↕ mm	↔ mm	↶ m	Deb. pl. mm	Teža kg/kos	Enota	
227	40	40	-	2	0.44	kos	
228	50	50	-	2	0.64	kos	
226	60	80	-	2	0.96	kos	
224	100	100	-	2	1.44	kos	
225	100	200	-	2	1.88	kos	
247	100	300	-	2	2.36	kos	

2 mm

Pokrov zunanjega kolena 45° RIS

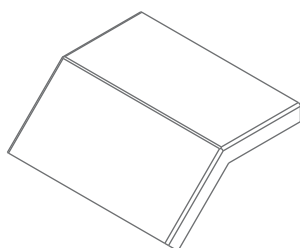

Material:		Pocinkana pločevina					
Koda	↕ mm	↔ mm	↶ m	Deb. pl. mm	Teža kg/kos	Enota	
4227	-	40	-	2	0.32	kos	
4228	-	50	-	2	0.41	kos	
4226	-	80	-	2	0.66	kos	
4224	-	100	-	2	0.82	kos	
4225	-	200	-	2	1.56	kos	
4274	-	300	-	2	2.31	kos	

2 mm

Notranje koleno 90° RIS

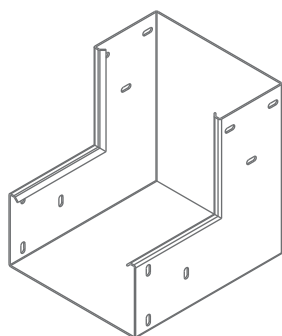

Material:		Pocinkana pločevina					
Koda	↕ mm	↔ mm	↔ m	Deb. pl. mm	Teža kg/kos	Enota	
161	40	40	-	2	0,80	kos	
163	50	50	-	2	0,98	kos	
164	60	80	-	2	1,30	kos	
155	100	100	-	2	1,90	kos	
139	100	200	-	2	2,60	kos	
275	100	300	-	2	3,25	kos	

2 mm

Notranje koleno 45° RIS

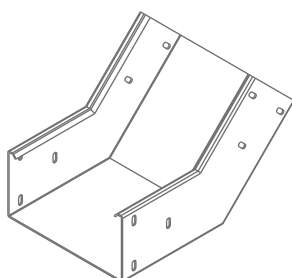

Material:		Pocinkana pločevina					
Koda	↕ mm	↔ mm	↔ m	Deb. pl. mm	Teža kg/kos	Enota	
229	40	40	-	2	0,88	kos	
230	50	50	-	2	1,00	kos	
231	60	80	-	2	1,43	kos	
232	100	100	-	2	2,10	kos	
233	100	200	-	2	2,86	kos	
276	100	300	-	2	3,52	kos	

2 mm

Reducirni element RIS

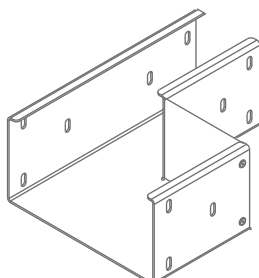

Material:		Pocinkana pločevina					
Koda	↕ mm	↔ mm	↔ m	Deb. pl. mm	Teža kg/kos	Enota	
176L	100	300/200L	-	2	3,10	kos	
176D	100	300/200D	-	2	3,10	kos	

OPOMBA: L = levo koleno, D = desno koleno

2 mm

Pokrov reducirnega elementa RIS

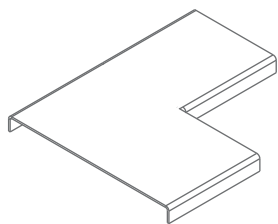

Material: Pocinkana pločevina

Koda	↕ mm	↔ mm	↔ m	Deb. pl. mm	Teža kg/kos	Enota
4176L	-	300/200L	-	2	1.8	kos
4176D	-	300/200D	-	2	1.8	kos

OPOMBA: L = levo koleno, D = desno koleno

1 mm

Instalacijski kanal RIS

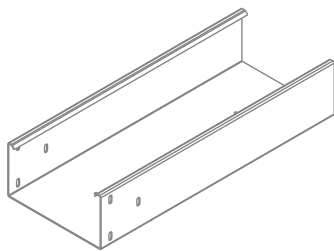

Material:		Pocinkana pločevina					
Koda	↕ mm	↔ mm	↔ m	Deb. pl. mm	Teža kg/kos	Enota	
0300300	30	30	2	1	1,57	m	
234	40	40	2	1	2,10	m	
200	50	50	2	1	2,60	m	
201	60	80	2	1	3,45	m	
192	60	100	2	1	3,81	m	
191	60	150	2	1	4,68	m	
120	100	100	2	1	5,20	m	
121	100	200	2	1	6,70	m	

1 mm

Instalacijski kanal RIS + pregrada

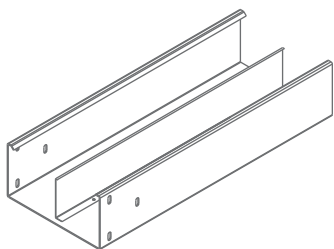

Material:		Pocinkana pločevina					
Koda	↕ mm	↔ mm	↔ m	Deb. pl. mm	Teža kg/kos	Enota	
292	100	200	2	1	8,62	m	

1 mm

Pokrov RIS

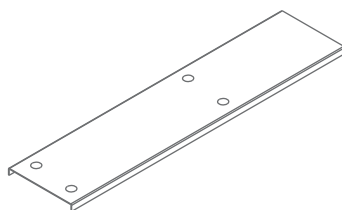

Material:		Pocinkana pločevina					
Koda	↕ mm	↔ mm	↔ m	Deb. pl. mm	Teža kg/kos	Enota	
184	-	30	2	1	0,88	m	
235	-	40	2	1	1,05	m	
135	-	50	2	1	1,35	m	
202	-	80	2	1	1,70	m	
136	-	100	2	1	2,00	m	
193	-	150	2	1	2,80	m	
137	-	200	2	1	3,60	m	

1 mm

Pregrada RIS

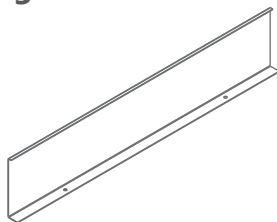

Material: Pocinkana pločevina

Koda	↑ mm	↔ mm	↔ m	Deb. pl. mm	Teža kg/kos	Enota
138	-	-	2	1	1,9	kos

OPOMBA: Samo za instalacijski kanal 200x100!

1 mm

Spojnica RIS

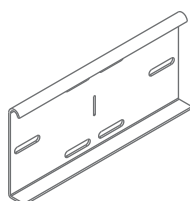

Material: Pocinkana pločevina

Koda	↑ mm	↔ mm	↔ m	Deb. pl. mm	Teža kg/kos	Enota
236	40	-	-	1	0,08	kos
237	50	-	-	1	0,10	kos
238	60	-	-	1	0,12	kos
197	100	-	-	1	0,19	kos

OPOMBA: Samo za instalacijski kanale debljine 1 mm.

1 mm

Končni element RIS

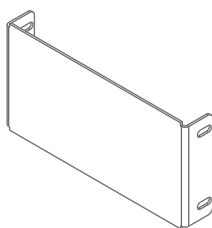

Material: Pocinkana pločevina

Koda	↑ mm	↔ mm	↔ m	Deb. pl. mm	Teža kg/kos	Enota
243	40	40	-	1	0,03	kos
242	50	50	-	1	0,04	kos
241	60	80	-	1	0,06	kos
277	60	100	-	1	0,08	kos
278	60	150	-	1	0,10	kos
239	100	100	-	1	0,12	kos
240	100	200	-	1	0,19	kos

OPOMBA: Samo za instalacijski kanale debljine 1 mm.

1 mm

Ravninsko koleno 90° RIS

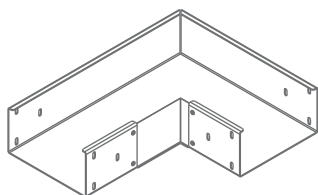

Material: Pocinkana pločevina

Koda	↕ mm	↔ mm	↔ m	Deb. pl. mm	Teža kg/kos	Enota
246	40	40	-	1	0.36	kos
245	50	50	-	1	0.45	kos
244	60	80	-	1	0.75	kos
203	60	100	-	1	0.89	kos
189	60	150	-	1	1.10	kos
124	100	100	-	1	1.20	kos
129	100	200	-	1	1.91	kos

1 mm

Pokrov ravninskega kolena 90° RIS

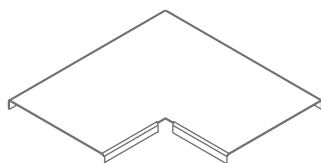

Material: Pocinkana pločevina

Koda	↕ mm	↔ mm	↔ m	Deb. pl. mm	Teža kg/kos	Enota
4246	-	40	-	1	0.12	kos
4245	-	50	-	1	0.16	kos
4244	-	80	-	1	0.26	kos
4203	-	100	-	1	0.36	kos
4189	-	150	-	1	0.54	kos
4124	-	100	-	1	0.36	kos
4129	-	200	-	1	0.82	kos

1 mm

Ravninsko koleno 45° RIS

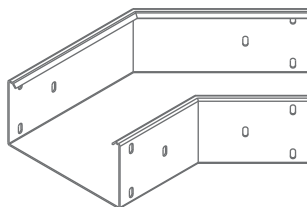

Material: Pocinkana pločevina

Koda	↕ mm	↔ mm	↔ m	Deb. pl. mm	Teža kg/kos	Enota
247	40	40	-	1	0.48	kos
248	50	50	-	1	0.60	kos
249	60	80	-	1	0.75	kos
279	60	100	-	1	0.90	kos
280	60	150	-	1	1,30	kos
250	100	100	-	1	1.12	kos
251	100	200	-	1	1.5	kos

1 mm

Pokrov ravninskega kolena 45° RIS

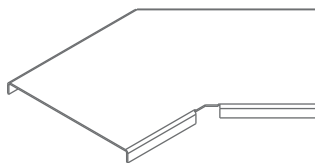

Material:		Pocinkana pločevina					
Koda	↕ mm	↔ mm	↔ m	Deb. pl. mm	Teža kg/kos	Enota	
4247	-	40	-	1	0.12	kos	
4248	-	50	-	1	0.14	kos	
4249	-	80	-	1	0.22	kos	
4279	-	100	-	1	0.28	kos	
4280	-	150	-	1	0.41	kos	
4250	-	100	-	1	0.28	kos	
4251	-	200	-	1	0.5	kos	

1 mm

T koleno RIS

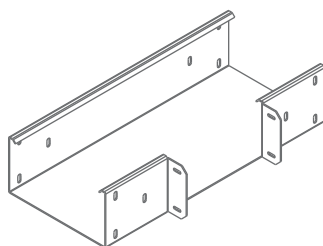

Material:		Pocinkana pločevina					
Koda	↕ mm	↔ mm	↔ m	Deb. pl. mm	Teža kg/kos	Enota	
256	40	40/40/40	-	1	0.27	kos	
255	50	50/50/50	-	1	0.34	kos	
254	60	80/80/80	-	1	0.55	kos	
281	60	100/100/100	-	1	0.85	kos	
282	60	150/150/150	-	1	1.36	kos	
253	100	100/100/100	-	1	0.85	kos	
252	100	100/200/100	-	1	1.06	kos	
257	100	200/100/200	-	1	1.12	kos	
133	100	200/200/200	-	1	1.36	kos	

1 mm

Pokrov T kolenoa RIS

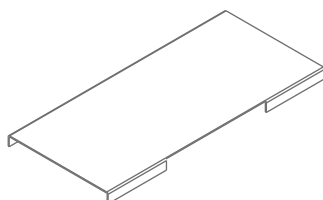

Material:		Pocinkana pločevina					
Koda	↕ mm	↔ mm	↔ m	Deb. pl. mm	Teža kg/kos	Enota	
4256	-	40/40/40	-	1	0.10	kos	
4255	-	50/50/50	-	1	0.12	kos	
4254	-	80/80/80	-	1	0.19	kos	
4281	-	100/100/100	-	1	0.29	kos	
4282	-	150/150/150	-	1	0.42	kos	
4253	-	100/100/100	-	1	0.29	kos	
4252	-	100/200/100	-	1	0.26	kos	
4257	-	200/100/200	-	1	0.73	kos	
4133	-	200/200/200	-	1	0.69	kos	

1 mm

Zunanje koleno 90° RIS

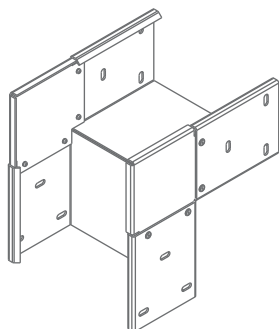

Material: Pocinkana pločevina

Koda	↑ mm	↔ mm	↔ m	Deb. pl. mm	Teža kg/kos	Enota
258	40	40	-	1	0.28	kos
168	50	50	-	1	0.40	kos
169	60	80	-	1	0.60	kos
283	60	100	-	1	0.75	kos
284	60	150	-	1	1.10	kos
165	100	100	-	1	0.90	kos
171	100	200	-	1	1.18	kos

1 mm

Pokrov zunajega kolena 90° RIS

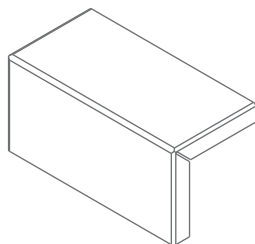

Material: Pocinkana pločevina

Koda	↑ mm	↔ mm	↔ m	Deb. pl. mm	Teža kg/kos	Enota
4258	-	40	-	1	0.16	kos
4168	-	50	-	1	0.20	kos
4169	-	80	-	1	0.33	kos
4283	-	100	-	1	0.41	kos
4284	-	150	-	1	0.60	kos
4165	-	100	-	1	0.41	kos
4171	-	200	-	1	0.78	kos

1 mm

Zunanje koleno 45° RIS

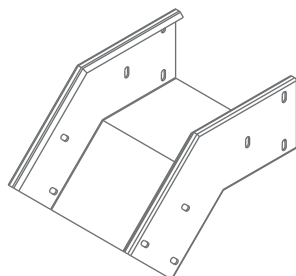

Material: Pocinkana pločevina

Koda	↑ mm	↔ mm	↔ m	Deb. pl. mm	Teža kg/kos	Enota
261	40	40	-	1	0.22	kos
260	50	50	-	1	0.32	kos
259	60	80	-	1	0.48	kos
285	60	100	-	1	0.72	kos
286	60	150	-	1	1.10	kos
165	100	100	-	1	0.72	kos
171	100	200	-	1	0.94	kos

1 mm

Pokrov zunanjega kolena 45° RIS

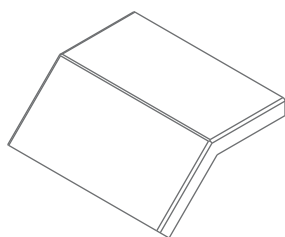

Material:		Pocinkana pločevina					
Koda	↕ mm	↔ mm	↔ m	Deb. pl. mm	Teža kg/kos	Enota	
4261	-	40	-	1	0.16	kos	
4260	-	50	-	1	0.21	kos	
4259	-	80	-	1	0.33	kos	
4285	-	100	-	1	0.41	kos	
4286	-	150	-	1	0.61	kos	
4165	-	100	-	1	0.41	kos	
4171	-	200	-	1	0.78	kos	

1 mm

Notranje koleno 90° RIS

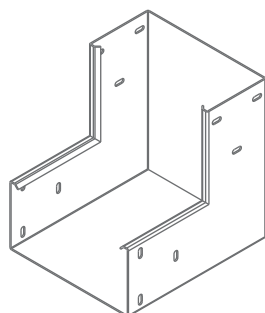

Material:		Pocinkana pločevina					
Koda	↕ mm	↔ mm	↔ m	Deb. pl. mm	Teža kg/kos	Enota	
265	40	40	-	1	0,40	kos	
264	50	50	-	1	0,49	kos	
263	60	80	-	1	0,65	kos	
287	60	100	-	1	0,72	kos	
288	60	150	-	1	0,88	kos	
262	100	100	-	1	0,95	kos	
196	100	200	-	1	1,30	kos	

1 mm

Notranje koleno 45 RIS

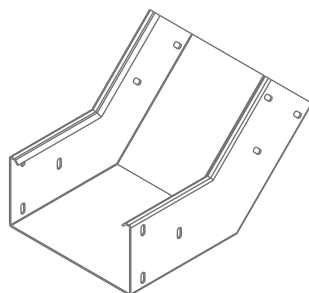

Material:		Pocinkana pločevina					
Koda	↕ mm	↔ mm	↔ m	Deb. pl. mm	Teža kg/kos	Enota	
270	40	40	-	1	0.44	kos	
269	50	50	-	1	0.50	kos	
268	60	80	-	1	0.58	kos	
289	60	100	-	1	0.63	kos	
290	60	150	-	1	0.93	kos	
267	100	100	-	1	1.05	kos	
266	100	200	-	1	1.43	kos	

Pribor

Vijak VE-03



Površinska zaščita: Galvansko cinkano

Koda	↕ mm	↔ mm	↔ m	Deb. pl. mm	Teža kg/100 kos	Enota
40701	-	-	-	-	1,32	kos

OPOMBA: Pakirano po 100 kos..

Pribor

Vijak podaljšan VE-03 P



Površinska zaščita: Galvansko cinkano

Koda	↕ mm	↔ mm	↔ m	Deb. pl. mm	Teža kg/100 kos	Enota
40703	-	-	-	-	1,37	kos

OPOMBA: Pakirano po 100 kos..

Pribor

Stenski nosilec ZNL



Material: Pocinkana pločevina

Oznaka	Koda	↕ mm	↔ mm	↔ m	Deb. pl. mm	Teža kg/kos	Enota
ZNL 50	45050	-	50	-	?	0,18	kos
ZNL 100	15100	-	100	-	?	0,24	kos
ZNL 200	45200	-	200	-	?	0,34	kos
ZNL 300	4300	-	300	-	?	0,72	kos

Pribor

Zapah pokrova ZAP-1



Površinska zaščita: Galvansko cinkano

Oznaka	Koda	↕ mm	↔ mm	↔ m	Deb. pl. mm	Teža kg/100 kos	Enota
ZAP-1	40009	-	-	-	-	0,84	kos

OPOMBA: Pakirano po 60 kos..

Samo za instalacijski kanale debeline 1 mm.

Navodila za montažo:

1 Opcija: Namestitev pregrade

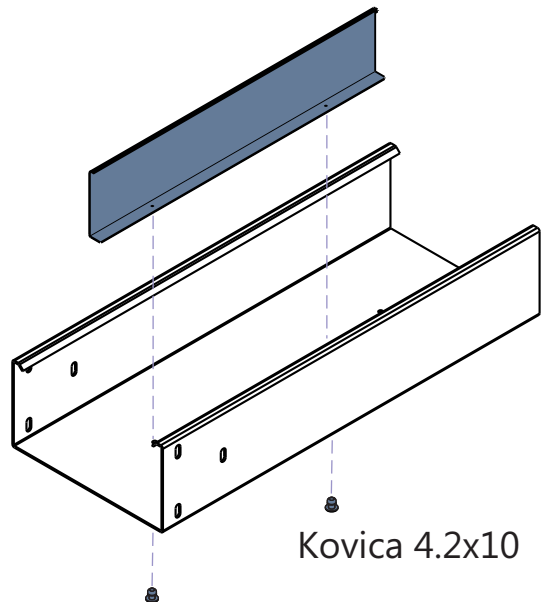

2 Spajanje kanala

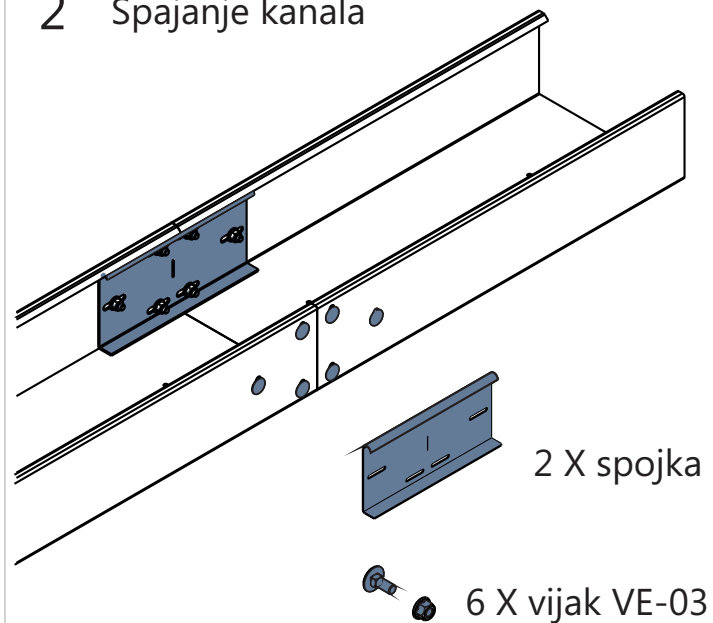

3 Pritrditev kanala

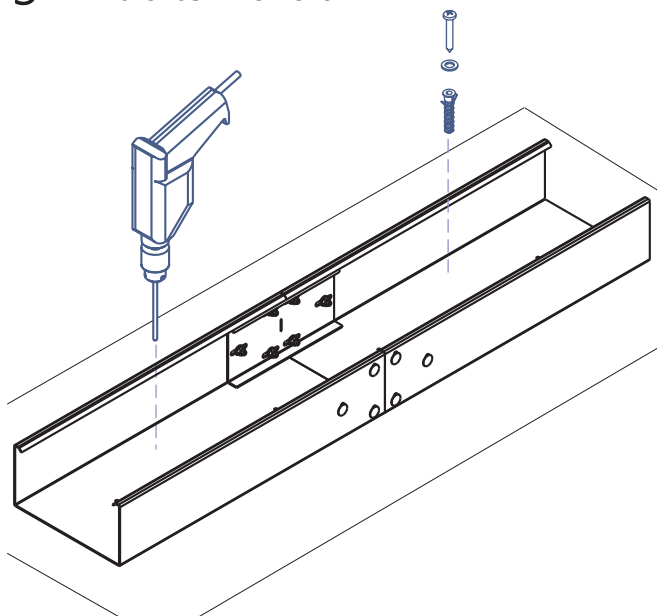

4 Ozemljitev kanala

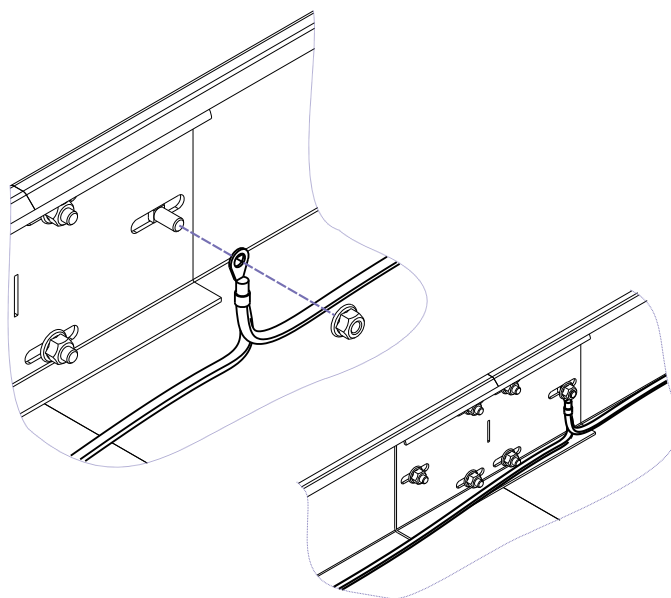

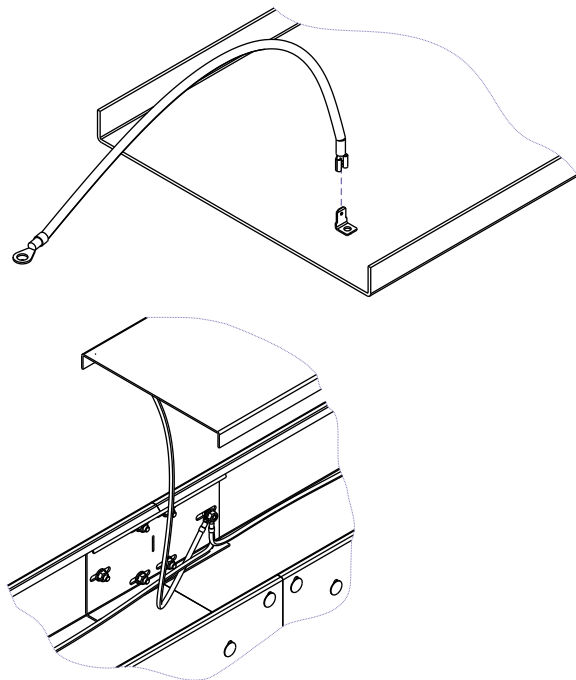
Navodila za montažo:**5 Ozemljitev pokrova****6 Namestitev pokrova**